

SMD LED (Top View Type 3528 Pre Mold Lead Frame) 外觀圖示

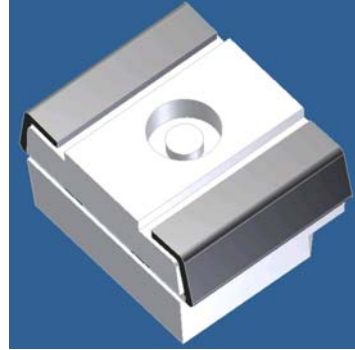

物理性質

發光角: 120°
 電氣傳導率: 85 min. %IACS
 熱傳導率: 347 W/m.k
 抗拉強度: 295~375 N/mm²
 熱膨脹係數: 17.7 10⁻⁶/°C
 塑膠軟化點: 318°C at(0.45MPa)
 融化點: 321°C
 吸濕率: 0.24% (24hrs)

機械性質

尺寸: 3.5x 2.8x 1.9 mm
 銅材材質: TAMAC-4 and CDA 194
 塑膠材質: PPA A4122 WH 117
 接腳數: 2 PIN
 電鍍: 全鍍+單面功能區選鍍銀
 電鍍膜厚:
 Option 1: Spot Ag 2.5um min. + Flash Ag 1.5um min
 Option 2: Spot Ag 2.5um min. + Flash Ag 0.127um min
 料片尺寸: 144(L)x 49(W)x 0.15(T)mm
 單片顆數: 180 Pcs

機械尺寸

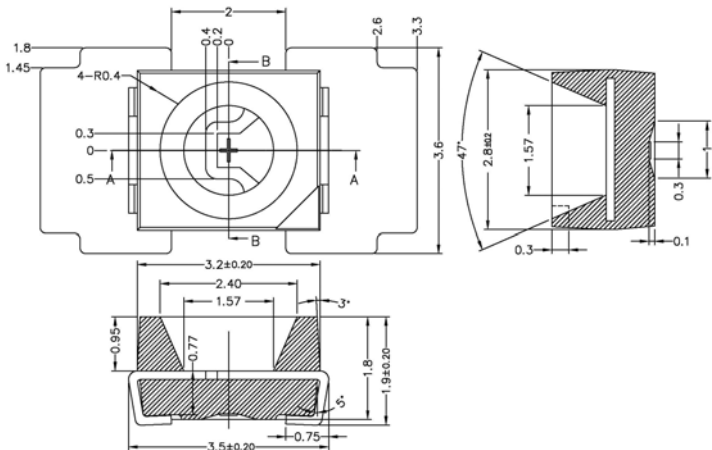

產品應用

戶外顯示燈
 信號顯示燈
 閃光燈

